

Rev.	Description	Date
01	Release for Production	07/24/2012

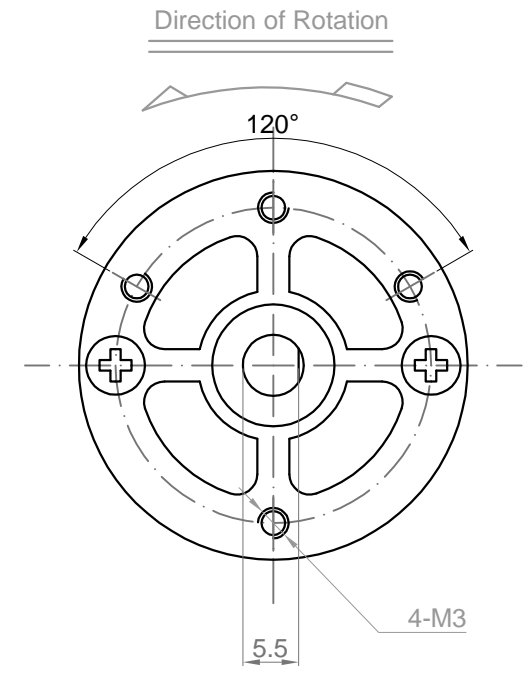
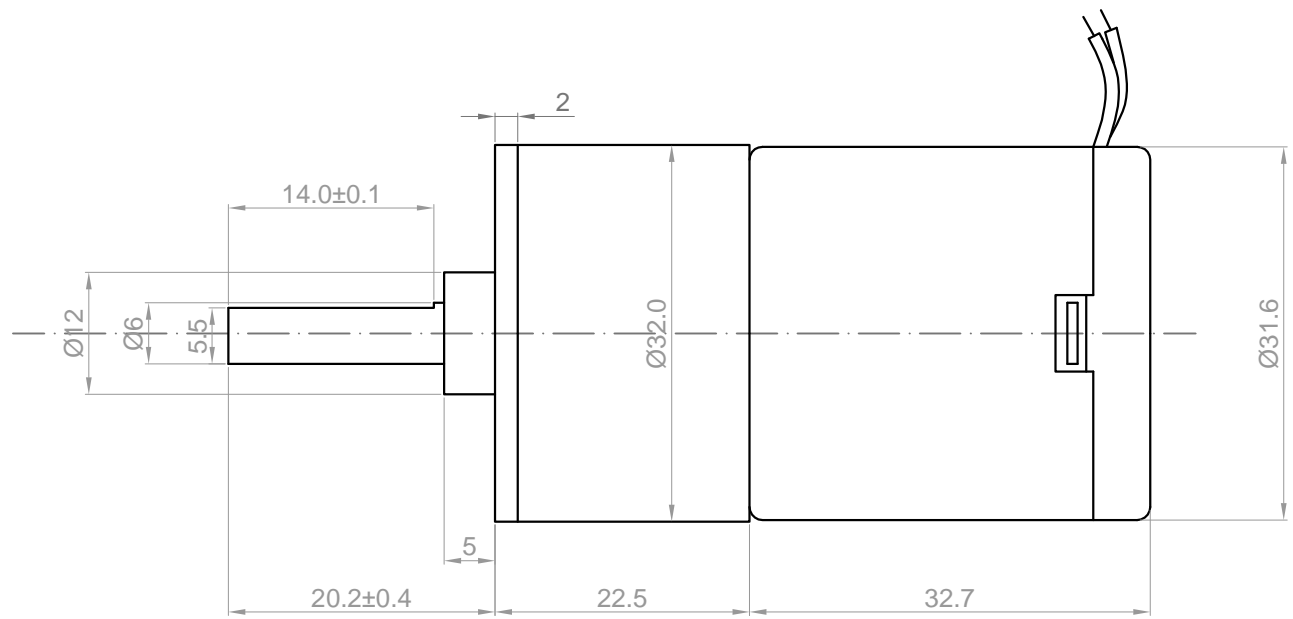

NO.	Item	Specification	NO.	Item	Specification
1	Rated Voltage	12 VDC	7	Stall Torque	135 mN·M
2	No Load Speed	360±10% RPM	8	Stall Current	783 mA
3	No Load Current	25mA	9		
4	Rated Speed	305±10%RPM	10		
5	Rated Current	140 mA	11		
6	Rated Load	20 mN·M	12		

Drawn	L	04/15/2016	Kysan Electronics www.kysanelectronics.com info@kysanelectronics.com		
Checked					
Eng Appr.					
Mfg Appr.					
Q.A.					
SKU	1151729		Size : A4	Weight(Kg):0.5	Unit: mm
			Scale: 3:1		Sheet 1of 1