

NO.	ITEM	SPECIFICATION
1	Rated Voltage	110 VAC
2	Rated Frequency	60 Hz
3	Rated Speed	5 RPM
4	Input Power	2.5 W Max
5	Input Current	35 mA Max
6	Rated Torque	2.5 Kg.cm
7	Rotation Direction	CW / CCW / Free
8	Temperature Rise	60K Max

Rev.	Revision	Date
01	Update	11/8/2011

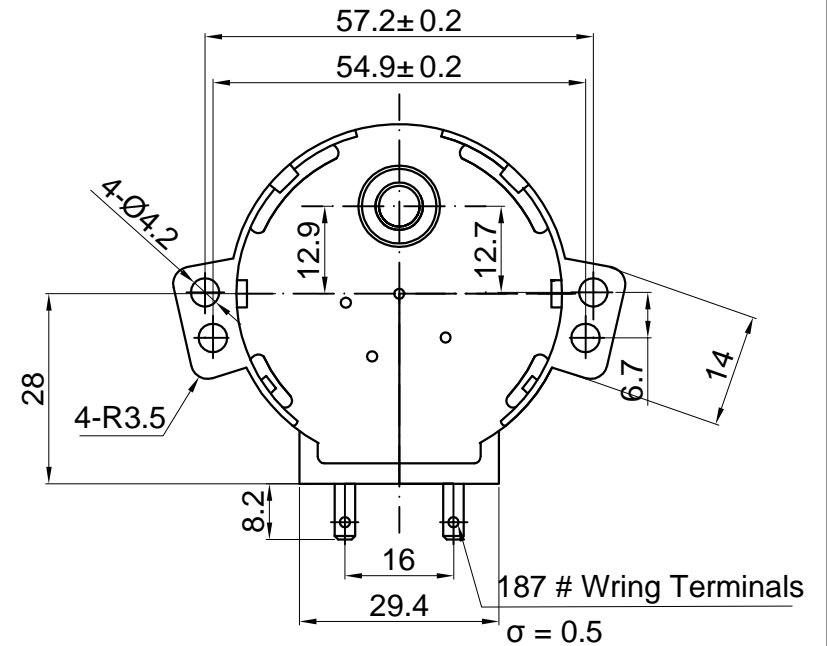
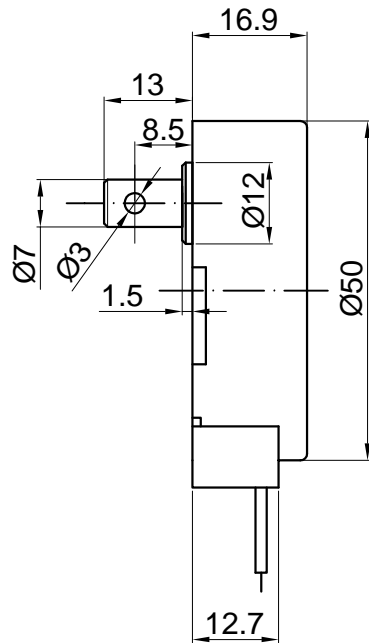

DRAWN	Emily	11/8/2011
CHECKED	Sara	11/8/2011
ENG APPR.		
MFG APPR.		
Q.A.		

UNIT: mm

Kysan Electronics

SKU
1311076

SIZE
A4

Email
info@kysanelectronics.com

REV
01

SCALE: 2:1

Weight(kg):

SHEET 1 OF 1